



Number	Category	Name
1	<a href="#">Table top</a>	<a href="#">SK3TUT</a>
2	<a href="#">Knives and scissors</a>	<a href="#">SK3CUT</a>
3	<a href="#">Electric cutters</a>	<a href="#">SK3EC</a>
4	<a href="#">Vacuum leak detectors</a>	<a href="#">SK3VLD</a>
5	<a href="#">Protective profile for the edges of parts made of PCA</a>	<a href="#">SK3EP</a>
6	<a href="#">Infrared thermometer</a>	<a href="#">SK3TIR</a>
7	<a href="#">Paddles</a>	<a href="#">SK3SPA</a>
8	<a href="#">Rollers</a>	<a href="#">SK3ROL</a>
9	<a href="#">Temperature calibrator GMINGT250</a>	<a href="#">SK3TCT-1</a>



# VIK-COMPOSITE CATALOGUE MISCELLANEOUS

10	<a href="#">Thermocouple welder GMIAT100-V2</a>	<a href="#">SK3TCW-1</a>
11	<a href="#">Thermocouple</a>	<a href="#">SK3TC-1GMI</a>
12	<a href="#">Insulating Material</a>	<a href="#">GMITI010</a>
13	<a href="#">Vacuum traps for resin</a>	<a href="#">SK3VAC</a>
14	<a href="#">Mobile v acuum system vacuum system with vacuum sources and resin traps</a>	<a href="#">SK1MOVAC</a>
15	<a href="#">Membrane</a>	<a href="#">SK2RIM180-7</a>
16	<a href="#">Metal container for injection reservoir</a>	<a href="#">SK3MC-1</a>
17	<a href="#">Shrink tapes</a>	<a href="#">SK2SHR</a>
18	<a href="#">Cleaning cloth</a>	<a href="#">SK3MSC</a>
19	<a href="#">Technical wiping rag</a>	<a href="#">SK3WP</a>



[Back to content](#)

### ► DESCRIPTION

The table top SK3TUT-1 is manufactured using the highest grade of polyurethane. The using surfaces always provide a smooth, non-contaminated and silicone free working area. We recommend our double side adhesive tape: SK2AT60-1 for holding SK3TUT-1 to the table.

This product is used in various manufacturing processes of parts made of polymer composite materials.

### ► TECHNICAL DATA

Material type: PUR  
Colour: Blue  
Hardness: 90 +/- 5 Shore A

### ► SIZE

Thickness	Width	Length
6,5mm	1000mm	2000mm
6,5mm	1200mm	2500mm
6,5mm	1200mm	3000mm
6,0mm	1300mm	3000mm

Shelf life: unlimited

Storage conditions: it is recommended to store at temperature from +10°C until +30°C in the original packing.

### ► NOTE

Other sizes and colors are available on special order.



# KNIVES AND SCISSORS

## RANGE

[Back to content](#)

Material can be cleaned with mild detergent wash.

Name	Description
<a href="#">SK3CUT-1</a>	Manual knife with fixed blade for cutting composite materials
<a href="#">SK3CUT-21</a>	Set of blade for manual knife for cutting composite materials
<a href="#">SK3CUT-3</a>	Sturdy tailor's shears for cutting glass, carbon, Aramid fibre with 2 micro-serrated blades, 25cm
<a href="#">SK3CUT-4</a>	Sturdy tailor's shears for cutting glass, carbon, Aramid fibres with 2 micro-serrated blades, 30cm
<a href="#">SK3CUT-5</a>	Sturdy scissors for cutting almost any technical materials, 25cm
<a href="#">SK3CUT-6</a>	Sturdy universal scissors for cutting glass, carbon and Aramid fibres with 1 micro-serrated blade and wire cutter, 20cm
<a href="#">SK3CUT-7</a>	Sturdy universal tailor's shears for cutting glass, carbon and Aramid fibres with 1 micro-serrated, 25cm
<a href="#">SK3CUT-8</a>	Sturdy universal tailor's shears for cutting glass, carbon and Aramid fibres with 2 micro-serrated blades, 25cm
<a href="#">SK3CUT-10</a>	Scissors for cutting of technical fabrics
<a href="#">SK3EC-1</a>	Cordless rotary shear for cutting composite materials with blade size 5,16cm, cutting capacity: 0,96 cm
<a href="#">SK3EC-2</a>	Mini-cutters for cutting composite materials, cutting capacity 3,2mm
<a href="#">SK3CUT-9</a>	Scissors Grinding Machine



# TECHNICAL DATA SHEET

## SK3CUT-1

### Knife for cutting composite materials

[Back to range](#)

#### ► DESCRIPTION

The knife is specially produced for cutting staple fibres made from various materials (glass, carbon, basalt, Aramid, PE, PP fibres) feature high standards of reliability and excellent durability. The blades are made of high-quality, special-alloy strip steel. Close tolerances and perfectly ground finishes guarantee the required cutting.

This product is used in various manufacturing processes of parts made of polymer composite materials.

#### ► TECHNICAL DATA

Blade length: 32,8mm

Blade height: 5,7mm

Blade thickness: 0,5mm



#### ► NOTE

Please contact us for ordering additional blades for SK3CUT-1:

Blades in 0,5 mm Carbon steel + TiN:	SK3CUT-21
Blades in 0,5 mm Carbon steel:	SK3CUT-23





# TECHNICAL DATA SHEET

## SK3CUT-21 Blades for knife SK3CUT-1

[Back to range](#)

### ► DESCRIPTION

The blades are made of high-quality, special-alloy strip steel with TiN coating special for cutting staple fibres made from various materials (glass, carbon, basalt, Aramid, PE, PP fibres) feature high standards of reliability and excellent durability. Close tolerances and perfectly ground finishes guarantee the required cutting.

This product is used in various manufacturing processes of parts made of polymer composite materials

### ► TECHNICAL DATA

Blade length:	32,8mm
Blade height:	5,7mm
Blade thickness:	0,5mm



### ► NOTE

Please contact us for ordering additional blades for SK3CUT-1:  
Blades in 0,5 mm Carbon steel: SK3CUT-23





[Back to range](#)

#### ► DESCRIPTION

Sturdy tailor's shears for cutting glass, carbon, Aramid fibres with 2 micro-serrated blades.

This product is used in various manufacturing processes of parts made of polymer composite materials.

#### ► TECHNICAL DATA

Blade length: 120mm

Scissors length: 250mm

Scissors weight: 320g



#### ► NOTE

Please contact us for ordering scissors of different size.



[Back to range](#)

#### ► DESCRIPTION

Sturdy tailor's shears for cutting glass, carbon, Aramid fibres with 2 micro-serrated blades.

This product is used in various manufacturing processes of parts made of polymer composite materials.

#### ► TECHNICAL DATA

Blade length: 140mm

Scissors length: 300mm

Scissors weight: 360g



#### ► NOTE

Please contact us for ordering scissors of different size.



[Back to range](#)

#### ► DESCRIPTION

Sturdy scissors for cutting almost any technical materials.

This product is used in various manufacturing processes of parts made of polymer composite materials.

#### ► TECHNICAL DATA

Blade length: 125mm

Scissors length: 250mm

Scissors weight: 276g



#### ► NOTE

Please contact us for ordering scissors of different size.



[Back to range](#)

#### ► DESCRIPTION

Sturdy universal scissors for cutting glass, carbon and Aramid fibres with 1 micro- serrated blade and wire cutter.

This product is used in various manufacturing processes of parts made of polymer composite materials.

#### ► TECHNICAL DATA

Blade length:	75mm
Scissors length:	200mm
Scissors weight:	164g



#### ► NOTE

Please contact us for ordering scissors of different size.





[Back to range](#)

#### ► DESCRIPTION

Sturdy universal tailor's shears for cutting glass, carbon and Aramid fibres with 1 micro-serrated blade.

This product is used in various manufacturing processes of parts made of polymer composite materials.

#### ► TECHNICAL DATA

Blade length: 120mm

Scissors length: 250mm

Scissors weight: 230g



#### ► NOTE

Please contact us for ordering scissors of different size.



[Back to range](#)

#### ► DESCRIPTION

Sturdy universal tailor's shears for cutting glass, carbon and Aramid fibres with 2 micro-serrated blades.

This product is used in various manufacturing processes of parts made of polymer composite materials.

#### ► TECHNICAL DATA

Blade length:	120mm
Scissors length:	250mm
Scissors weight:	230g



#### ► NOTE

Please contact us for ordering scissors of different size.

[Back to content](#)

#### ► DESCRIPTION

Standard scissors for cutting almost any technical fabrics made of stable steel.

This product is used in various manufacturing processes of parts made of polymer composite materials.

#### ► TECHNICAL DATA

Scissors length: 200mm

Scissors weight: 150g



#### ► NOTE

Please contact us for ordering scissors of different size.



[Back to content](#)

#### ► DESCRIPTION

It is a powerful, professional grade, cordless rotary shear which is designed with the big precision cutting features and the convenience and portability that is afforded by battery power. The rotary shear is equipped with a 5,16cm blade and a 7.2 volt battery pack - allowing for longer run time.

Set is equipped with charger and a spare battery for backup. Battery charger will fully recharge the battery in one hour. The rotary shear allows to cut through heavier and industrial-type material with relative ease. The cutting head features a fixed shear plate with a spring-loaded blade to insure an effortless and clean “scissors cut” through the lightest materials without jamming.

This product is used in various manufacturing processes of parts made of polymer composite materials.

#### ► TECHNICAL DATA

Motors:	7.2V
Horsepower:	0.33hp
Blade Size:	5.16 cm
Charger:	110v 60hz 220v 50hz
Cutting Capacity:	0.96 cm max



#### ► SIZE

Weight of shears	Size of the packing	Weight of packing
1,22kg	0,51m x 0,28m x 0,23m	3,63kg

#### ► NOTE

Ergonomically designed handle is well suited for both left and right-handed operation. Standard are circular blades.



Semi-Square and octagon blades are available on special order.

#### ► DESCRIPTION

Electric Cordless Mini-Cutter is perfect for your all-purpose cutting needs. It is lightweight and versatile - easily cutting through all fabrics, paper, leather as well as Kevlar, Carbon und Glass. It features a cordless, rechargeable system and can also operate with AC power. The mini-cutter is a lightweight and easy-to-use industrial cutting tool, with easy fingertip trigger control.

This product is used in various manufacturing processes of parts made of polymer composite materials.

Content of EC Cutter Set Standard:

1. Scissors body
2. All purpose short blades assembly (for accurate curve cutting)
3. Blades assembly with base plate (for stable straight cutting)
4. Transformer
5. Rechargeable battery
6. Battery charger



#### ► TECHNICAL DATA

Motors:	7.5V
Horsepower:	0.35hp
Weight of shears:	0,25kg
Charger:	110v 60hz 220v 50hz
Cutting Capacity:	3.2mm max

#### ► NOTE



Replacement blades and accessories are available on special order.



## SK3CUT-9 Scissors Grinding Machine

[Back to content](#)

### ► DESCRIPTION

SK3CUT-9 - scissor grinding machine, made by Maier, satisfying demands of perfect cutting edges on scissors of any kind and size. The scissors are tightly fixed and the easily movable grinding arm guarantees secure grinding, ensuring no displacement during grinding. The cutting angle may be adjusted from 0 to 60 degrees. This machine solves the problem of poor cutting scissors in a simple and very economical way. Dull scissors can be reground immediately, without waiting time.

This product is used in various manufacturing processes of parts made of composite materials.

### ► TECHNICAL DATA

Grinding spindle speed:	approx. 2 850 rpm
Capacity:	20-30 scissors per hour
Motor:	230V, 50Hz, 375W.





# VACUUM LEAK DETECTORS

## RANGE

[Back to content](#)

Name	Description
<a href="#">SK3VLD-1</a>	Vacuum leak detector
<a href="#">SK3VLD-3</a>	Economical vacuum leak detector

### ► DESCRIPTION

Numerous preventive maintenance tasks for leak detections can be handled quickly and efficiently with the SONAPHONE Pocket. Lower your energy costs and increase your operational safety with the most compact testing device of the SONAPHONE series.

Advantages of devise:

- Find leaks and save energy
- Compact design
- Easy to use
- Extensive accessories for a wide range of applications

The ultrasonic testing device is used for:

- Vacuum leak localization by creation of the vacuum bag,
- Leak detection with compressed air, gas and vacuum systems,
- Providing evidence of partial electrical discharges where there is insulation damage,
- Functional testing of steam traps and valves
- Tightness testing of unpressurised systems.

The compact testing device is designed to fit in any pocket. However, its robust construction means it is also appropriate for harsh industrial environments.

The SONAPHONE Pocket is supplemented by extensive accessories in the form of airborne and structure-borne sound probes. You will receive the appropriate probe for your application from our product range, which you can attach to the device with just one simple movement.

You do not need much time or expensive training in order to perform the test procedure. The testing device makes the ultrasonic signals audible and shows them on a digital display at the same time. The SONAPHONE Pocket – easy to handle and very effective.

This product is used in various manufacturing processes of parts made of polymer composite materials.

### ► OVERVIEW

#### SONAPHONE POCKET – Basic Set

Consisting of: SONAPHONE Pocket, noise protected stereo headphones with coiled cable, transport case, lanyard, batteries, user documentation.



### SONAPHONE POCKET – Leak Detection Set

Consisting of: SONAPHONE Pocket, airborne sound probe L 50, directional tube with tip, acoustic horn for airborne sound probe L 50, leak tags (25 pcs.), noise protected stereo headphones with coiled cable, transport case, lanyard, batteries, user documentation.



### Application Set Leak Detection

Consisting of: airborne sound probe L 50, directional tube with tip, acoustic horn, leak tags (25 pcs.)

### ► PRESENTATION OF COMPACT ULTRASONIC TESTING DEVICE FOR PREVENTIVE MAINTENANCE



Airborne probe for quick and easy leak detection on compressed air, gas and vacuum systems

At 85 x 130 x 30 mm the SONAPHONE Pocket fits into any jacket pocket



Slot for airborne and structure-borne probes – perfect for different applications

Digital display of the ultrasonic level – rapid assessment of condition of machines and systems

Gathering the maximum value at a glance

Robust construction – ideal for harsh testing environments

### ► TECHNICAL DATA

Transmission frequency:  
Functionality:

40 kHz, bandwidth +/- 2 kHz  
Detection of ultrasonic signals: Makes the ultrasonic signals audible and shows them on a digital display;  
Auto-power-off-function

Display:  
Connections:

LC-Display with illuminated background  
For different ultrasonic probes  
Stereo jack socket

Power supply:  
Operating time:  
Operating temperature:  
Storage temperature:  
Protection class:  
Accessories of Basic Set:

2 AA batteries or accumulators  
Approx. 24 h  
-10 °C ... +60°C  
-20 °C ... +60°C  
Device: IP54; Probe: IP20  
Headphones, carrying strap, carrying case, instruction manual

### ► SIZE

Weight of devise	Size of the devise
280 g	85 x 130 x 30 mm







### ► NOTE



# TECHNICAL DATA SHEET

## SK3VLD-1 Vacuum leak detector

### Available accessories

Name	Application	Picture
Leak Detection Set for SONAPHONE Pocket incl. airborne sound probe, directional tube with tip, acoustic horn	detection of vacuum leakage	
Air-borne probe L 50 for SONAPHONE Pocket	leak detection, proof of seal failures	
Contact Probe L 51 for SONAPHONE Pocket	inspection of valves, slide and safety valves	
Contact Probe L 52 for SONAPHONE Pocket	testing of steam traps, inspection of rotating machines	
Flexible air-borne sound probe L 53 for SONAPHONE Pocket	leak detection at places, difficult to access	
Parabolic Dish SONOSPOT for SONAPHONE Pocket	precise detection of leaks or partial discharges over long distances	
Spherical Transmitter SONOSPHERE for SONAPHONE T Accessories: stand, magnetic and suction holder	leak testing of cabins and containers (in combination with SONAPHONE T and SONAPHONE Pocket)	

SONAPHONE T  
Adjustable Ultrasonic  
Transmitter

Reliable Detection of Leaks





#### ► DESCRIPTION

The ultrasonic detector SK3VLD-3 is a compact economical sensitive light device for finding leaks in vacuum bags, sealing of bags, vacuum hoses and fittings. Receiver converts the ultrasonic sound produced by leaks into visually displays on graph meter and audible signal. The signal is increasing as closer the receiver is moved to the leak source.

This product is used in various manufacturing processes of parts made of polymer composite materials.

#### ► EQUIPMENT COMPONENTS

Detector body receiver  
Stainless steel contact probe  
Alkaline battery  
Hard carrying case incl. foam inserts

Flexible hole probe  
Stereo head set  
User's manual







# TECHNICAL DATA SHEET

**SK3VLD-3**

**Economical vacuum leak detector**

## ► TECHNICAL DATA

Power source:	9V battery
Battery Type:	Std. 9 Volt Alkaline
Frequency response:	38-42 kHz
Heterodyne Filter:	4kHz
Display:	Ten element bar graph
Run Time:	Up to 200 hours

## ► SIZE

Weight of device, not packed	Size of the carrying case	Weight of set in carrying case
0,138kg	0,076m x 0,27m x 0,33m	1,36 kg

## ► OPERATION INSTRUCTIONS

Install the hollow probe or stainless steel contact probe into the hole in the receiver.  
Plug in headset to the receiver.  
For turn on hold the On/Off button for 3 seconds.  
Adjust sound level on headset and sensitivity level on unit.  
Slowly move the probe over suspected leaking area until leak is detected.  
For turn off hold the On/Off button for 3 seconds.

## ► NOTE

Please contact us if you need a kit with industrial grade noise cancelling head set.  
Standard warranty period: 12 months.



# TECHNICAL DATA SHEET

## SK3EP-1

### Protective profile for the edges of parts made of PCM

[Back to content](#)

#### ► DESCRIPTION

U-type flexible foam profile SK3EP-1 protects the edges and the angles of the parts, preventing damages while transport, storage and operation.

The profile can be used to protect the edges in thickness from 5mm up to 16mm.

This product is used in various manufacturing processes of parts made of polymer composite materials.

#### ► TECHNICAL DATA

Material type: Low density polyethylene of foamy structure.  
Color: Blue

Thickness	Width	Length
7mm	30mm	500mm
7mm	30mm	1000mm

Shelf life: unlimited

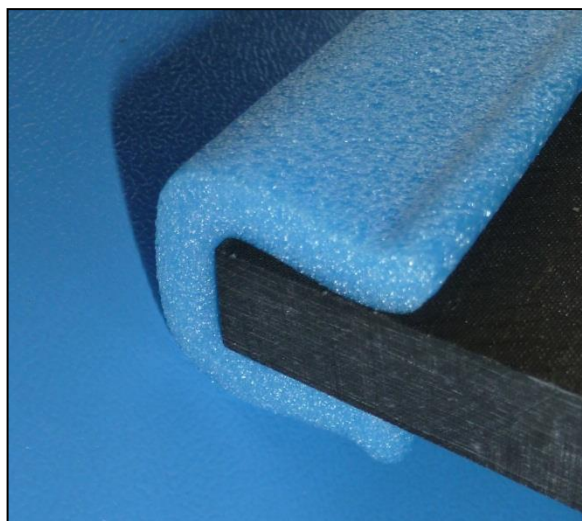

#### ► NOTE

Please, contact us for ordering profile of another length.



[Back to content](#)

### ► DESCRIPTION

The precise and compact device for contactless measurement of temperature. The thermometer is convenient for the temperature control of resin and potential exothermic peak in the process of vacuum infusion. The operator traces the points of thermometer target owing to the built in laser pointer.

This product is used in various manufacturing processes of parts made of polymer composite materials.

### ► TECHNICAL DATA

Color:	Black
Measurement range:	-33°C / 250°C
Accuracy:	+/-2°C
Graduation mark:	0,1°C
Optical resolution:	3:1



Size	Weight	Boxed weight
2,2cm x 6,0cm x 10,4cm	0,109kg	0,141kg

### ► NOTE

Aim the thermometer at the object and press the "Scan" button for temperature measurement. The temperature value displays. For use the other functions press the "Mode" button.

[Back to content](#)

Power supply: two lithium-type batteries CR2032 3V

### ► DESCRIPTION

Paddles are used to facilitate the laying up of prepreg, layers of reinforcing and auxiliary materials on the complex radius as well as for bonding of adhesive decorative film. It helps to smooth wrinkles and to remove air bubbles entrapped between the layers. The ergonomic shape and grip ridge for the finger in the middle of the paddle make its use easy and effective.

This product is used in various manufacturing processes of parts made of polymer composite materials.

### ► TECHNICAL DATA

Material type: High-density polyethylene  
Color: White/Blue

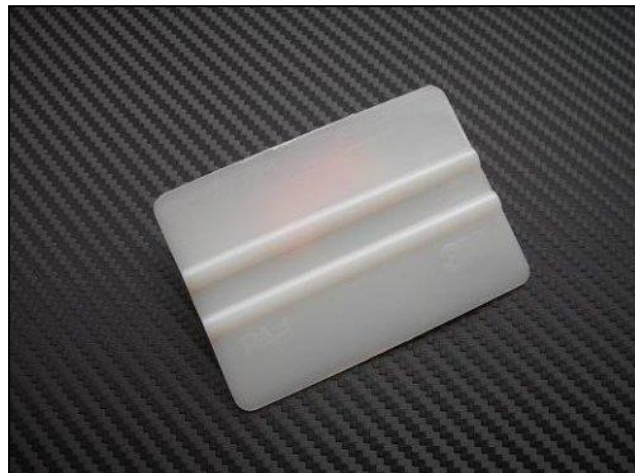

Thickness	Width	Length
3mm	70mm	100mm

Shelf life: unlimited



# ROLLERS

## RANGE

[Back to content](#)

Name	Description
<a href="#">SK3ROL-1</a>	Hand roller
<a href="#">SK3ROL-2ST</a>	Electrically heated cylinder-shaped roller
<a href="#">SK3ROL-2TS</a>	Electrically heated trapezoid-shaped roller

### ► DESCRIPTION

Hand roller for prepreg layer compaction and sealant tape application.

The roller insures proper adhesion between film and sealant tape, and between sealant tape and tool during the bag sealing. It is specially designed to save time and labour. The roller has an inert plastic roller, a steel frame and a wooden handle.

This product is used in various manufacturing processes of parts made of composite materials.

### ► TECHNICAL DATA

Material type roller:	Inert plastic
Color:	Grey



Shelf life: unlimited

#### ► DESCRIPTION

Electrically heated cylinder-shaped roller for prepreg layer compaction and lay-out which contribute to a better elimination of air cavities from interlayer space of laminate and to reduction of the operator's labor efforts.

The temperature of the roller can be set in the temperature range from 30°C to 110°C. The axis and fork plate of the roller are made of high quality steel and the jacket of the roller is made of elastomer. The roller is equipped with an ergonomical handle as well as a flexible and elastic cable 3 m long which allows using it for large size products.

#### ► ROLLER TECHNICAL DATA

Material type roller:	Bronze + Stainless steel
Material type roller jacket:	Silicon elastomer
Roller height with handle:	250 mm
Power:	200 W
Thermosensor in the roller:	PT100
Cable length:	3 m
Voltage:	230 V
Electric current:	0,9 A



#### ► SIZE

Reference for order	Roller diameter without jacket	Roller width
SK3ROL-2W50ST	40 mm	50 mm
SK3ROL-2W86ST	40 mm	86 mm

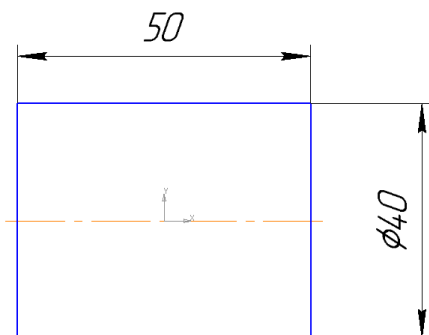

Pic.1 : SK3ROL-2W50ST

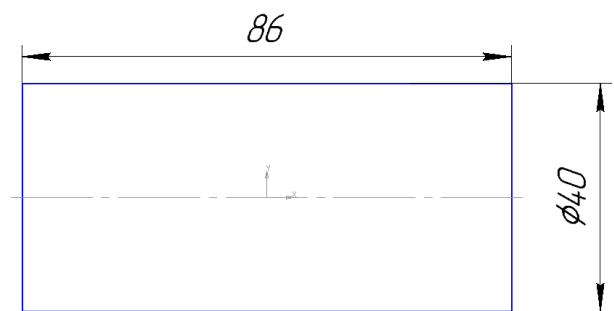

Pic.2 : SK3ROL-2W86ST





# TECHNICAL DATA SHEET

## SK3ROL-2ST

### Electrically heated cylinder-shaped roller

The roller is supplied with a remote compact thermocontroller PID R08 S/L/1000/230/TBF in a plastic frame with a control board and a digital display showing the preset and real temperature values.

The thermocontroller is equipped with temperature automatic control functions preventing the overheating of the roller and a function of visual warning in case of trouble. There is a push button and a viewer for system restart in case of regime failure. The system is equipped with a fuse.

#### ► THERMOCONTROLLER TECHNICAL DATA

Power:	1000 W
Voltage:	230 V
Frequency:	50 Hz
Max working temperature:	110 °C
Accuracy:	+/- 1,1 °C
Electric current:	4,5 A
Thermocontroller size:	160 mm x 120 mm x 260 mm

#### ► DESCRIPTION

Electrically heated trapezoid-shaped roller for prepreg layer compaction and lay-out which contribute to a better elimination of air cavities from interlayer space of laminate and to reduction of the operator's labor efforts.

The temperature of the roller can be set in the temperature range from 30°C to 110°C. The axis and fork plate of the roller are made of high quality steel and the jacket of the roller is made of elastomer. The roller is equipped with an ergonomical handle as well as a flexible and elastic cable 3 m long which allows using it for large size products.

#### ► ROLLER TECHNICAL DATA

Material type roller:	Bronze + Stainless steel
Material type roller jacket:	Silicon elastomer
Roller height with handle:	250 mm
Power:	200 W
Thermosensor in the roller:	PT100
Cable length:	3 m
Voltage:	230 V
Electric current:	0,9 A



#### ► SIZE

Reference for order	Roller diameter without jacket	Roller width
SK3ROL-2W50TS	40 mm x 45 mm	50 mm
SK3ROL-2W86TS	40 mm x 45 mm	86 mm

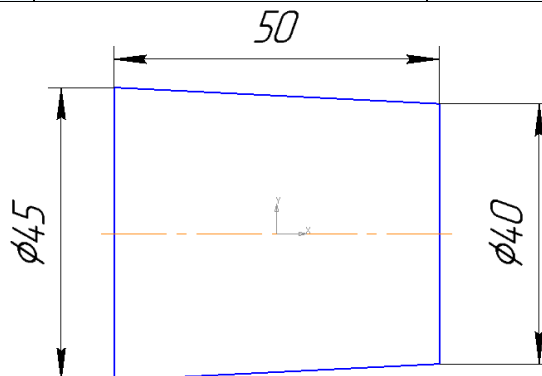

Pic.1 : SK3ROL-2W50TS



# TECHNICAL DATA SHEET

## SK3ROL-2TS

### Electrically heated trapezoid-shaped roller

The roller is supplied with a remote compact thermocontroller PID R08 S/L/1000/230/TBF in a plastic frame with a control board and a digital display showing the preset and real temperature values.

The thermocontroller is equipped with temperature automatic control functions preventing the overheating of the roller and a function of visual warning in case of trouble. There is a push button and a viewer for system restart in case of regime failure. The system is equipped with a fuse.

#### ► THERMOCONTROLLER TECHNICAL DATA

Power:	1000 W
Voltage:	230 V
Frequency:	50 Hz
Max working temperature:	110 °C
Accuracy:	+/- 1,1 °C
Electric current:	4,5 A
Thermocontroller size:	160 mm x 120 mm x 260 mm

#### ► DESCRIPTION

The portable device used for the calibration of the thermocouples. Its operating principles are according to the Simulation of Thermocouples by production of voltage. It simulates Thermocouples Type J suitable for the ANITA Consoles made by GMI AERO. It can also be used for other needs where it is required to simulate Thermocouples Type K or T.

Keyboard is used for selection of operation functions and for values. Display shows in Degree Celsius or Fahrenheit. Its operations are very simple. In calibration mode, the operator connects the instrument to the ANITA Console thermocouple plugs. Device will be delivered with user manual for all possible functions and certificate of calibration registered to NIST. Effectively, the instrument can also be used as a classical thermocouple thermometer (one channel).



#### ► TECHNICAL DATA

Simulates and measures:	Thermocouples Type J, K, or T
Display:	5 dig its
Resolution:	0,1°C (0.2°F)
Precision:	0,3°C (0,6°F)
Battery:	9 VDC
Operating conditions:	0 to 50°C; 0 to 90% HR
Dimensions of device:	178 x 74 x 28 mm
Weight of device:	0,341 kg

#### ► DESCRIPTION

Very handy equipment to solder the thermocouple cable tip and thus assures good quality to temperature readings. In a context of field repair and workshop activity this equipment will be very useful; its operation mode is straightforward.

This portable instrument will be a necessary companion for repairing in the field thermocouple cables. Fine welded tips are easily obtained. Measurement process is improved and process receipt is thus conducted with guarantee.

In Composite Manufacturing Processes this equipment will be also of important value. Thermocouples for the autoclaves, ovens, presses, moulds etc....can be easily and regularly maintained.

The welder is presented in a nice convenient light and portable case. It works on rechargeable batteries. Performing a weld is straightforward: strip the two leads, touch a special base in the console, and press a switch. You get a reliable welded tip

#### ► TECHNICAL DATA

Dimensions: 370 x 240 x 240 mm  
Weight: 6 Kg

#### ► DELIVERED CONTECT

- A stripping clamp
- Goggles
- A user Manual



#### ► NOTES

Battery: when loaded, the battery allows several tenths of welds.



### ► DESCRIPTION

Thermocouples are used for temperature control under vacuum bag and inside of laminate during manufacturing process and repair of parts made of composite materials.

Thermocouples are delivered with the established plug compatible with ANITA bonding console for bonding under vacuum, as well as with temperature systems for all ovens and Thermo Infusion Automatic Centers (TIAC) delivered by company STEVIK.

This product is used in various manufacturing processes of parts made of polymer composite materials.

### ► TECHNICAL DATA

Thermocouple type:	J	
Length:	3m	
Initial accuracy of measurement:	+/-2,2°C	ASTM 230 standard
Overall dimensions of the cable:	1,3 x 1,9 mm	
Gauge of individual wire:	AWG24 or 0,5 mm	

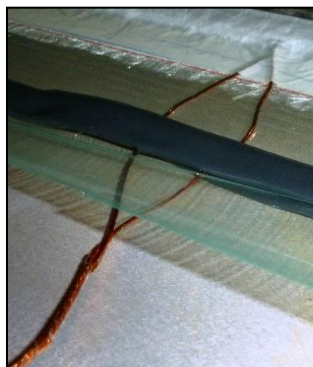

### ► NOTE

Please contact us for ordering thermocouple of another length.  
Shelf life: unlimited





### ► DESCRIPTION

This insulating material made by GMI-AERO used to protect areas from being overheated during the composite repair processes. The material is developed as a sandwich construction with aluminium foil both side and glass wool in between and has an excellent isolation performance. The experience of GMI allowed to create the product, which can be used as well as excellent insulator against heat losses by radiation and convection. Typical application of the material: repair of elevator; bonding an adhesive in bottom of hole in honeycomb.

This product is used in various manufacturing processes of parts made of composite materials.

### ► TECHNICAL DATA

Cover both side:	Aluminium foil
Core material:	Glass wool
Thickness of alum. foil:	0,05 mm
Total thickness:	8 mm



### ► SIZE

Width	Length	Packaging
450mm	750mm	1 sheet

Shelf life: unlimited

Storage conditions: it is recommended to store at temperature from +10°C until +30°C in the original packing.

### ► NOTE

Other sizes are available on special order.





# VACUUM TRAPS

## RANGE

[Back to content](#)

Name	Description
<a href="#">SK3VAC-5L</a>	Vacuum trap 5,6 л
<a href="#">SK3VAC-15L</a>	Vacuum trap 14,7 л
<a href="#">SK3VAC-53L</a>	Industrial vacuum trap 53 л

### ► DESCRIPTION

A big vacuum trap with silicon vacuum tight rim was developed to trap resin excess in the infusion process. The cover of the tank is made of plexiglass which helps to control pail filling in the tank with resin. Fittings construction allows to place the tubes end leads into the tank by putting them into the openings of the clamping fitting and twirling clamping ring. Thus in case of resin entry into the trap fitting will remain clean. At the end of the process the fixing fitting ring has to be untwisted and the tube is pulled out.

Each tank is equipped with:

- Polypropylene pail for resin trapping aimed at preventing the tank from contamination;
- Vacuum gauge;
- Valve for manual flow control;
- Quick disconnect plug SK2VV232-4 1/4" to connect vacuum to the tank;
- Clamping fitting for the tube with external diameter 12mm to connect resin channels. (Fittings for tubes 10mm and 16mm are available on special order).



### ► TECHNICAL DATA

Tank volume:	5.6 litres
Tank diameter / total:	20cm / 24cm
Total height of the tank:	38cm
Tank material:	aluminum
Fitting material:	stainless steel
Tube connection:	clamping fitting for tube 12mm
Vacuum connection:	quick disconnect plug 1/4"

The product can slightly differ from the photo depending on complete set.

### ► DESCRIPTION

A big vacuum trap with silicon hermetic rim was developed to trap resin excess in the infusion process. The cover of the tank is made of plexiglass which helps to control pail filling in the tank with resin. Fittings construction allows to place the tubes end leads into the tank by putting them into the openings of the clamping fitting. Thus in case of resin entry into the trap fitting will remain clean. At the end of the process the fixing fitting ring is pressed evenly from both sides and the tube is pulled out.

Each tank is equipped with:

- Polypropylene pail for resin trapping aimed at preventing the tank from contamination;
- Vacuum gauge;
- Valve for manual flow control;
- Quick disconnect plug SK2VV232-4 1/4" to connect vacuum to the tank;
- 4 clamping fittings for the tube with external diameter 12mm to connect resin channels. (Fittings for tubes 10mm and 16mm are available on special order).



Pic. 1: SK3VAC-15L0WR12x4



Pic. 2: Open connection



Pic. 3: Open cover



Pic.4: Top view

### ► TECHNICAL DATA

Tank volume:	14.7 litres
Tank diameter / total:	26cm / 30cm
Total height of the tank:	49 cm
Tank material:	aluminum
Fitting material:	stainless steel
Tube connection:	4 clamping fittings for tube 12mm
Vacuum connection:	quick disconnect plug 1/4"

Name	Description
SK3VAC-15L0WR12x4	Vacuum trap 14,7 l for resin with sealing system with round bottom including: 1 manual flow control valve, 1 vacuum gauge, 1 quick disconnect vacuum output ¼ "BSP, 4 clamping fittings for tube 12 mm.
SK3VAC-15L0WS12x4	Vacuum trap 14,7 l for resin with sealing system with square bottom including: 1 manual flow control valve, 1 vacuum gauge, 1 quick disconnect vacuum output ¼ "BSP, 4 clamping fittings for tube 12 mm.
SK3VAC-15L4WS12x4	Vacuum trap 14,7 l for resin with sealing system with square bottom and 4 wheels including: 1 manual flow control valve, 1 vacuum gauge, 1 quick disconnect vacuum output ¼ "BSP, 4 clamping fittings for tube 12 mm.



Pic. 5: Top view



Pic. 6: SK3VAC-15L4WS12x4

The product can slightly differ from the photo depending on complete set.



#### ► DESCRIPTION

A big industrial vacuum trap with silicon vacuum tight rim was developed to trap resin excess in the infusion process. The cover of the tank is made of plexiglass which helps to control pail filling in the tank with resin. Fittings construction allows to place the tubes end leads into the tank by putting them into the openings of the clamping fitting and twirling clamping ring. Thus in case of resin entry into the trap fitting will remain clean. At the end of the process the fixing fitting ring has to be untwisted and the tube is pulled out.

Each tank is equipped with:

- 20 L polypropylene pail for resin trapping aimed at preventing the tank from contamination;
- Vacuum gauge ;
- Valve for manual flow control;
- Vacuum lever regulator (option);
- Quick disconnect plug SK2VV232-4 1/4" to connect vacuum to the tank;
- 4 or 8 clamping fittings for the tube with external diameter 12mm to connect resin channels. (Fittings for tubes 10mm and 16mm are available on special order).



Pic. 1: 4 channel cover without vacuum level regulator



Pic. 2: Fitting



Pic. 3: Open cover with clamped tube

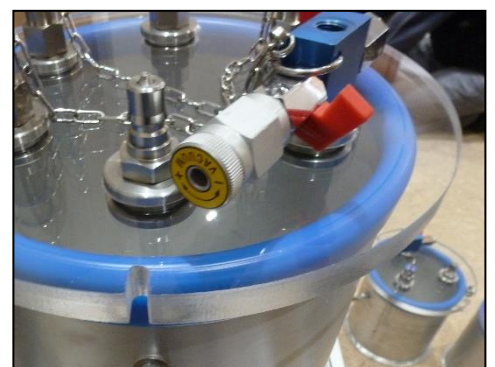

Pic. 4: Top view

#### ► TECHNICAL DATA

Tank volume:	53 litres
Tank diameter:	41,9 cm



# TECHNICAL DATA SHEET

## SK3VAC-53L

### Industrial vacuum trap for resin

Total height of the tank: 49 cm  
 Tank material: aluminum  
 Fitting material: stainless steel  
 Tube connection: 4 or 8 clamping fittings for tube 12mm  
 Vacuum connection: quick disconnect plug 1/4"

Reference	Description
SK3VAC-53L4WS12x4	Resin catch reservoir 53 l, incl. seal system, with square base with 4 wheels incl. 1 manual vacuum release valve, 1 vacuum gauge, 1 quick disconnect vacuum outlet ¼ " BSP, 4 push fittings for tube 12mm ID
SK3VAC-53L4WS12x4REG	Resin catch reservoir 53 l, incl. seal system, with square base with 4 wheels incl. 1 manual vacuum release valve, 1 vacuum gauge, 1 manual vacuum level regulator, 1 quick disconnect vacuum outlet ¼ " BSP, 4 push fittings for tube 12mm ID
SK3VAC-53L4WS12x8	Resin catch reservoir 53 l, incl. seal system, with square base with 4 wheels incl. 1 manual vacuum release valve, 1 vacuum gauge, 1 quick disconnect vacuum outlet ¼ " BSP, 8 push fittings for tube 12mm ID
SK3VAC-53L4WS12x8REG	Resin catch reservoir 53 l, incl. seal system, with square base with 4 wheels incl. 1 manual vacuum release valve, 1 vacuum gauge, 1 vacuum level regulator, 1 quick disconnect vacuum outlet ¼ " BSP, 8 push fittings for tube 12mm ID



Pic. 5: Top view of catch reservoir with 4 push fittings

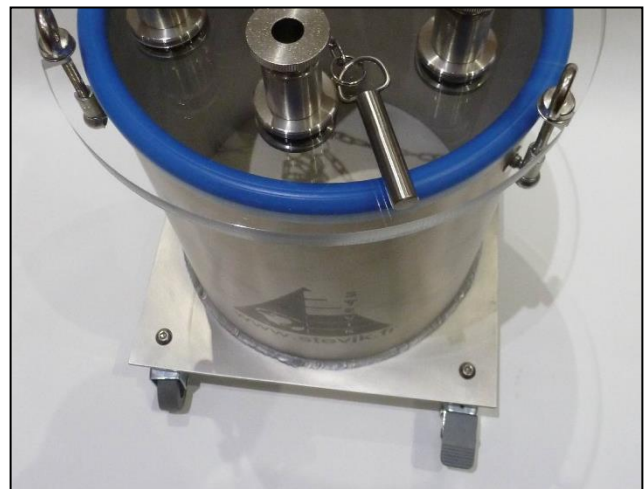

Pic. 6: SK3VAC-53L4WS12x4





The product can slightly differ from the photo depending on complete set.

## SK1MOVAC

### Mobile vacuum system with vacuum sources and resin traps

[Back to content](#)

#### ► DESCRIPTION

The unit SK1MOVAC is mobile vacuum equipment offering an excellent mobility in the composite shop – by using quick disconnection system. The system is placed on mobile lightweight aluminum platform as single phase powered. The MOVAC can be used in different composite manufacturing processes, like vacuum resin infusion, double bag infusion, RTM light and as well for vacuum debulking operations.

The resin traps are easy to remove and reconfigure, because they are placed on the platform without tools. The traps and vacuum control devices can be remotely located if requested.







# TECHNICAL DATA SHEET

## SK1MOVAC

Mobile vacuum system with vacuum sources and resin traps

### ► TECHNICAL CHARACTERISTICS

Cart components	Description
Mobile platform	Light aluminum structure 500mm x 1050mm x 850mm (WxLxH) with 2 levels. Equipped with 4 industrial wheels of Ø50mm and max. loading each 60kg. Two wheels are moveable with locking breaks, being easy to handle.
Quick disconnect system	3 plugs SK2VV232-4: 2 plugs on the frame of the cart in front of each trap and on the top of each trap 1 plugs.
Vacuum pumps	PVR EM20 Single phase 50 Hz capacity 18 m <sup>3</sup> /h and 60 Hz capacity 21 m <sup>3</sup> /h.
Vacuum level	Adjustable with special vacuum regulator from approximately 0% vacuum to the pump's maximum vacuum, as follows: PVR EM20 - 2 mbar (200 Pascal), 99,98% vacuum
Vacuum manometers	Range: 0 - (-1) bar Graduations: -0,02 bar Accuracy: +/-1,6%
Vacuum trap	System equipped with resin trap series: SK3VAC-15L with volume of 14,7 liters. Each tank is equipped with: <ul style="list-style-type: none"> <li>- Polypropylene pail for resin trapping aimed at preventing the tank from contamination;</li> <li>- Vacuum gauge;</li> <li>- Valve for manual flow control;</li> <li>- 4 clamping fittings for the tube with external diameter 12mm to connect resin channels. (Fittings for tubes 10mm and 16mm are available on special order).</li> </ul>

### ► CONFIGURATION:

Reference	Quantity of vacuum pumps	Quantity of vacuum traps
SK1MOVAC-1V1T	1	1
SK1MOVAC-2V1T	2	1
SK1MOVAC-2V2T	2	2

Please contact us for further information and for developing of the complex especially in accordance with your technical statement of work.



# TECHNICAL DATA SHEET

## SK1MOVAC

**Mobile vacuum system with  
vacuum sources and resin traps**

► **NOTE**

Please contact us for more detailed information as well as for system development according to your technical specification.

Standard warranty period: 12 months.



[Back to content](#)

### ► DESCRIPTION

The membrane is a micro porous multilayer system used in manufacturing processes for vacuum moulding of parts made of PCM with technologies such as prepreg, wet lay-up, and thermoplastic.

The fabric leaves a rough surface finish for secondary bonding and structural bonding. Membrane can be used with epoxy or phenolic resin systems. There is no release agent or silicon in the fabric.

This product is used in various manufacturing processes of parts made of composite materials.

### ► TECHNICAL DATA

Material of textile: Polyester  
Color: White  
Maximum use temperature: 180°C

### ► SIZE

Area weight	Thickness	Width	Length
130g/m <sup>2</sup>	200µm	1500mm	50m

Storage conditions: it is recommended from +10°C until +30°C and normal humidity.

### ► NOTE

MOQ is 1 roll.



# TECHNICAL DATA SHEET

## SK3MC-1

### Metal container for injection reservoir

[Back to range](#)

#### ► DESCRIPTION

SK3MC-1 is a metal container for using as one way can in the injection units SK1INJ and as Resin mixing can.

This product is used in various manufacturing processes of parts made of polymer composite materials.

#### ► TECHNICAL DATA

Material:	White iron for containers of 3L and 5 L Steel for container of 20 L
Diameter:	180 mm for containers of 3L and 5 L 280 mm for container of 20 L
Shape:	Cone-shape for containers of 3L and 5 L Cylindrical for container of 20 L
Color:	White
Interior surface:	Uncovered
Characteristics:	Open top
Handle:	Metal



SK3MC-1WH3L



SK3MC-1WH5L



SK3MC-1WH20L



# TECHNICAL DATA SHEET

**SK3MC-1**

**Metal container for injection reservoir**

► **SIZE**

Reference for order	Height	Capacity
SK3MC-1WH3L	160 mm	3 L
SK3MC-1WH5L	235 mm	5 L
SK3MC-1WH20L	378 mm	20 L

Shelf life: unlimited

Storage conditions: it is recommended to store at temperatures between -20°C and +30°C in the original packing.

► **NOTE**

MOQ 10 PCE of each.





# SHRINK TAPES

## RANGE

[Back to content](#)

Name	Description
<a href="#">SK2SHR100-1</a>	Shrink tape
<a href="#">SK2SHR180-1</a>	Shrink tape
<a href="#">SK2SHR230-1</a>	Shrink tape



# TECHNICAL DATA SHEET

## SK2SHR100-1 Shrink tape

### ► DESCRIPTION

SK2SHR100-1 is a tough, flexible, heat shrinkable polyester film with one side PTFE release coating. When wrapped around the object an object and heated, the tape has the unique ability to shrink while applying pressure. The compression force characteristics of the shrink tape make it an effective and useful tool for consolidating and compacting advanced composite parts during cure. In addition, the tape can be used effectively for compressing, debulking, shaping, forming and banding various materials. It is not adhesive coated and it is typically removed after the composite part is cured. Not reusable.

### ► TECHNICAL DATA

Material type:	Polyester tape with PTFE coating
Color:	White
Maximum use temperature:	100°C
Shrink temperature:	65°C
Shrink percentage:	20%
Shrink force:	8,59 lbs

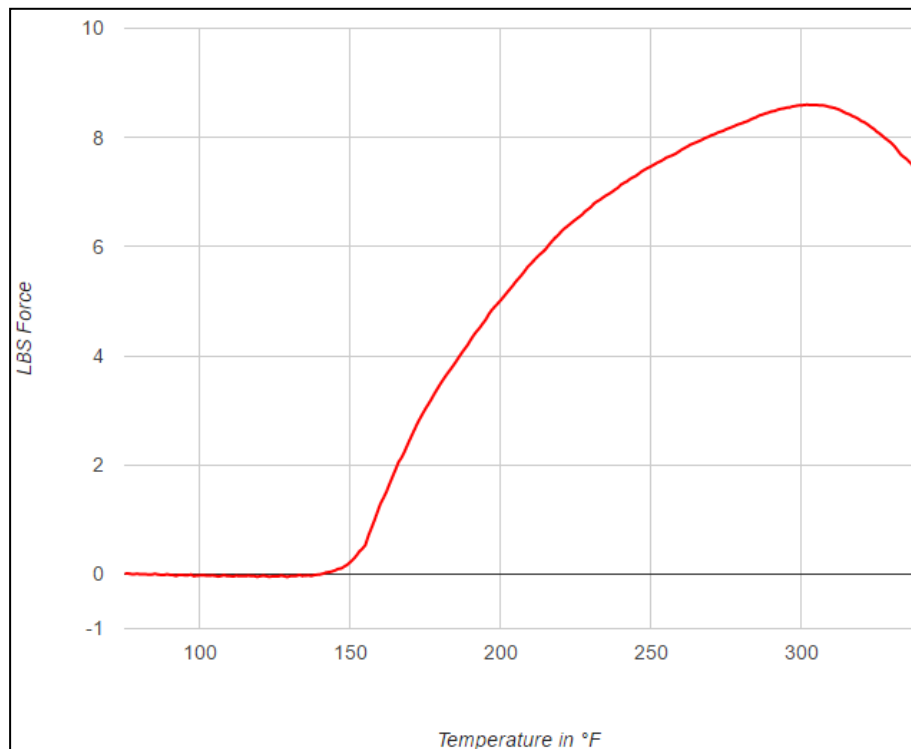

Shrink force vs temperature graph for SK2SHR100-1



# TECHNICAL DATA SHEET

**SK2SHR100-1**  
**Shrink tape**

► **SIZE**

Thickness	Width	Length
0,05mm	12mm	90m
0,05mm	62,5mm	90m

Shelf life: not limited.

Storage conditions: it is recommended to store at temperature from -20°C till + 30°C in the original packing.

► **NOTE**

Other widths are available on special order. The product is available in perforated version.

### ► DESCRIPTION

SK2SHR180-1 is a tape that has a unique ability to shrink with the application of heat. This characteristic makes the tapes useful in various industries as a processing aid during manufacturing as a simple method of applying external force to underlying part requiring compaction during cure. The product combines the high compaction forces of polyester shrink tape with the high temperature release characteristics of polyvinyl fluoride (PVF) film. The compression force characteristics of polyester based films make them effective and useful tools for consolidating and compressing composite parts in variety of manufacturing processes. SK2SHR180-1 is commonly used in applications where superior release characteristics are requested in combination with compaction forces at higher cure temperatures. The tape has a fused PVF release layer on one side of the film which is specially designed to have zero transfer to the underlying composite part. The release properties of this high temperature coating in combination with its non-transfer characteristics make it far superior to other release coated products, including silicone coated films.

### ► TECHNICAL DATA

Material type:	Polyester tape with polyvenylfluoride coating
Color:	White
Maximum use temperature:	180°C
Shrink initiation temperature:	65-70°C
Shrink percentage:	20%
Shrink force:	10,74 lbs





# TECHNICAL DATA SHEET

**SK2SHR180-1**  
**Shrink tape**

► **SIZE**

Thickness	Width	Length
0,05mm	12mm	90m
0,05mm	62,5mm	90m

Shelf life: not limited.

Storage conditions: it is recommended to store at temperature from -20°C till + 30°C in the original packing.

► **NOTE**

Other widths are available on special order.

### ► DESCRIPTION

SK2SHR230-1 is ETFE based shrink film designed to provide release characteristics and moderate compaction forces at higher cure temperatures. It is a tough, flexible, high performance fluoropolymer release tape, which works well in a broad range of temperatures (until 230°C). SK2SHR230-1 is ideal for cure cycles above 180°C where moderate compaction force and effective release are needed in combination. In addition, the tape exhibits elongation characteristics that make it effective for wrapping and conforming over sharp corner radii and composite parts with non-uniform outside dimensions. Due to its combination of release, compaction and elongation characteristics, SK2SHR230-1 has become a popular replacement for composite application where PVF film was formerly used.

### ► TECHNICAL DATA

Material type:	multilayer ETFE/Nylon/ETFE
Color:	Opaque to yellow
Starts to shrink:	40°C
Maximum use temperature:	230°C
Melting point:	250°C
Shrink percentage:	12%
Max. elongation:	300%



### ► SIZE

Thickness	Width	Length
0,05mm	12mm	90m



# TECHNICAL DATA SHEET

**SK2SHR230-1**  
**Shrink tape**

0,05mm	62,5mm	90m
--------	--------	-----

Shelf life: not limited. Storage conditions: it is recommended to store at temperature from -20°C till + 30°C in the original packing.

► **NOTE**

Other sizes and shrink percentages are available on special order.

[Back to range](#)

#### ► DESCRIPTION

SK3MSC000-6 cotton cleaning cloth for cleaning and preparation of technological tool. This cloth is a clean lint free waffle towel, that ideally suits for using together with our cleaning agents SK2TR000-1, SK2TR000-2, SK2TR000-3, sealers SK2TR450-1, SK2TR450-2, SK2TR450-3 and release agents SK2TR450-4, SK2TR450-5, SK2TR450-6, SK2TR450-7, SK2TR450-8, SK2TR450-9, SK2TR450-11, SK2TR150-1, SK2TR250-1.

This product is used in various manufacturing processes of parts made of polymer composite materials.

#### ► TECHNICAL DATA

Material density: 160 g/m<sup>2</sup>  
 Weaving type: Waffle  
 Color: White



#### ► SIZE

Reference for order	Width	Length
SK3MSC000-6	45 cm	60 m

Shelf life: unlimited

Storage conditions: it is recommended to store at temperatures between -20°C and +30°C in the original packing.

#### ► NOTE





MOQ 3 rolls. By request it is possible to precut the roll into tissues.



[Back to range](#)

### ► DESCRIPTION

SK3WP – are absorbing repeat use wiping rags for any wiping applications and applying of release agents. SK3WP is chemical free and strong wet or dry, has the edge in performance and cost of using agents.

It is suitable for different applications in engineering, printing, automotive, glazing and sealants, marine, oil and gas, aviation and aerospace, transport industries.

### ► TECHNICAL DATA

Number of plies: 1  
Color: white

### ► PACKAGING

Reference	Size	Quantity	Weight	Format
SK3WP100	460 x 380 mm	100 wipers per box	1.1 kg (approx.)	Sheet
SK3WP300	460 x 380 mm	300 wipers per box	3.3 kg (approx.)	Roll

### ► ADVANTAGES

- Consistent quality and size
- Multiple applications
- Chemical free and absorbent
- Strong wet and dry
- Good bulk and low lint
- Will absorb up to 6 times its own weight
- Small footprint

Shelf life: not limited.

Storage conditions: it is recommended to store at temperature from -20°C to +30°C in the original package.

### ► NOTE



Minimum order quantity 60 boxes for SK3WP100 and 36 boxes for SK3WP300.